

Article

Synergy Effect during Water Treatment by Electric Discharge and Chlorination

Antonina P. Malyushevskaya ¹, Piotr Koszelnik ^{2,*}, Anna Yushchishina ³, Olena Mitryasova ⁴, Andrii Mats ⁵ and Renata Gruca-Rokosz ²

¹ Institute of Impulse Processes and Technologies, National Academy of Sciences of Ukraine, Bohoyavlensky Avenue, 43a, 54018 Mykolaiv, Ukraine; ninutsa@ukr.net

² Department of Environmental and Chemistry Engineering, Rzeszow University of Technology, Aleja Powstańców Warszawy 12, 35-959 Rzeszów, Poland; renatagr@prz.edu.pl

³ Department of Chemistry, V.O. Sukhomlynskyi National University of Mykolaiv, Nikolska Street, 24, 54030 Mykolaiv, Ukraine; yushchishinaanna@gmail.com

⁴ Department of Ecology, Petro Mohyla Black Sea National University, 68 Desantnykiv Street, 10, 54003 Mykolaiv, Ukraine; eco-terra@ukr.net

⁵ NGO "Open Environmental University", 8 Bereznya, 51, 54003 Mykolaiv, Ukraine; andrejmac3@gmail.com

* Correspondence: pkoszel@prz.edu.pl

Abstract: Water treatment, such as disinfection, is an integral stage of its use for human life. The use of plasma technology with high-voltage electric discharge in a liquid for obtaining a bactericidal effect is discussed. It has been experimentally shown that among the factors accompanying a high-voltage electric discharge in a liquid and affecting the viability of bacteria, cavitation is the main one. Simultaneous use of electric discharge in the special cavitation mode and oxidizing agents makes it possible to achieve stable disinfection of water. At the same time, bactericidal doses of the oxidizing agent are reduced by a factor of 10 relative to existing standards, and the energy costs for electric discharge exposure, enhanced by small doses of an oxidizing agent, are reduced by 6 times compared to the costs of disinfection by only an electric discharge.

Keywords: water quality; water treatment; plasma technologies for water purification; electric discharge cavitation; synergistic efficiency of water disinfection



Citation: Malyushevskaya, A.P.; Koszelnik, P.; Yushchishina, A.; Mitryasova, O.; Mats, A.; Gruca-Rokosz, R. Synergy Effect during Water Treatment by Electric Discharge and Chlorination.

Environments **2023**, *10*, 93.

<https://doi.org/10.3390/environments10060093>

<https://doi.org/10.3390/environments10060093>

Academic Editors: Zacharias Frontistis, Athanasia Petala and Adamantia A. Kampioti

Received: 20 April 2023

Revised: 16 May 2023

Accepted: 21 May 2023

Published: 1 June 2023



Copyright: © 2023 by the authors. Licensee MDPI, Basel, Switzerland. This article is an open access article distributed under the terms and conditions of the Creative Commons Attribution (CC BY) license (<https://creativecommons.org/licenses/by/4.0/>).

1. Introduction

The growth of the world's population and the associated increase in the consumption of water for drinking and technical purposes, as well as the negative human impact on the environment, led to the fact that by the beginning of the XXI century, fresh water has become one of the most essential and demanded resources for humankind. More than 1 billion people are currently constantly experiencing a lack of clean fresh water [1–3]. According to forecasts, by 2025, this problem will become even more acute in half of the countries of the world, and by the end of the century, two-thirds of the population of our planet will find themselves in a difficult situation due to the lack of drinking water [4]. The US Environmental Protection Agency estimates that nearly 35% of deaths in developing countries are attributable to contaminated water [5]. Pollution of rivers and streams with chemical and aggressive biological objects is one of the most pressing environmental problems. Polluted water entering natural reservoirs causes a chain of devastating consequences [6–8]. Then there is also an obvious need for domestic wastewater to be treated before it is returned, with the main goal being to avoid unacceptable damage to the environment. A modern method of wastewater treatment should include the choice of the desired level of disinfection and have long-term efficiency. The ultimate goal of wastewater treatment is the efficient management of water resources that is economically and environmentally justified.

Despite the huge number of studies devoted to the problem of water treatment, the relevance of the work carried out in this direction remains high. Modern authors [9–13] discuss various methods of water disinfection and their main advantages and disadvantages. Much attention is paid to both traditional methods of removing heterogeneous impurities of biological origin (chlorination, ozonation, ultraviolet radiation treatment), and non-traditional ones (e.g., plasma and membrane technologies). Attention should be paid to electrical methods that have demonstrated their effectiveness for the intensification of various processes [14–16].

The development of membrane technologies, namely micro-, nano-, and ultrafiltration and the reverse osmosis method, should be recognized as a breakthrough of the last few decades in matters of water treatment [17–21]. However, with all their advantages, membrane technologies have not yet become widespread as an independent tool for large-scale water treatment [22,23], and they remain an extremely effective but expensive element in the water treatment cycle at the fine post-treatment stage.

Undoubtedly, at present, water chlorination with various chlorine agents is one of the oldest and, nevertheless, the most common methods of treating domestic wastewater and preparing water from natural sources for safe human use. Along with the obvious advantages of this technology (relative simplicity of installations, consistently high productivity, high disinfecting ability, prolonged bactericidal action), there is an unremovable drawback of this technology—the formation of highly toxic carcinogenic compounds when interacting with organic impurities (e.g., trihalomethanes) [24–26].

Often, the doses of chlorine used in water treatment are dozens of times higher than the permissible; for example, when trying to reduce hepatitis A virus contamination, overchlorination is used [27,28]. However, due to its relative simplicity and depth of development of technical solutions for implementation, as well as the high adaptability of the method for use in large-scale treatment, chlorination is a leader in the systems for disinfecting water consumed by large human agglomerations.

Often, to reduce the number of chemicals required for the disinfection of wastewater, chlorination is supplemented with ozonation, which is also one of the oldest and most developed methods for disinfecting water and air. According to modern concepts, the mechanism of disinfection by ozonation is based on the ability of ozone to inactivate enzymes contained in animal and plant organisms, although this point of view is still awaiting final confirmation [29–32]. Significant advantages of disinfection by ozonation are the compactness of the units, the convenience of their operation, and the significant reagent economy.

However, ozonation is most often used as part of a combined method of water disinfection because ozone itself is toxic and excessive ozonation causes problems of environmental pollution. Undoubtedly, such problems can be overcome by complex technical measures, namely ozone recovery, chemisorption and adsorption of excess ozone and harmful by-products on porous materials, and its catalytic decomposition, but the desire for preventive measures to protect the environment makes these efforts inappropriate [33–35].

Ozonation in small doses is also combined with water disinfection using ultraviolet radiation. Currently, the most confirmed is the hypothesis of the action of UV rays on the protein colloids of the cytoplasm of bacterial cells, resulting in a violation of their structure and death [36–39]. The main and very serious disadvantage of the processes of water disinfection by both UV irradiation and ozonation is the absence of a bactericidal aftereffect, which is why these processes are usually combined with chemical disinfection by introducing disinfectants of a chemical nature in doses justified from an environmental and economic point of view.

Among the physical methods of water disinfection, the ultrasonic method is also known. There is no unified theory explaining the mechanism of the bactericidal action of ultrasound; however, most researchers believe that mechanical destruction of bacteria occurs in the ultrasonic field as a result of ultrasonic cavitation. The effectiveness of ultrasonic exposure depends on the shape of microorganisms, the strength and chemical

composition of the cell wall, the age of the culture, and the intensity and frequency of sonication [40,41].

By changing the duration and frequency of sounding, it is possible to influence almost all types of microorganisms; in the field of ultrasonic waves, Gram-positive and Gram-negative bacteria, aerobic and anaerobic bacteria, and rod-shaped, coccal, and other forms are disintegrated; sounding affects both vegetative and spore forms [42–44]. To date, the main limiting factor for adapting the ultrasonic method to treat large volumes of water is the limited power of ultrasonic sources. This limitation, in turn, is caused by the fact that with an increase in the power of the installation and the intensity of ultrasound, under the influence of cavitation, the elements of the vibration source itself are quickly destroyed.

Plasma technologies now occupy a prominent place among the tools for water purification from harmful and dangerous micropollutants [9] and are used in the treatment of domestic wastewater [45–47], recycling of wastewater from industrial enterprises [48–51], and bringing natural water from surface sources to the level of suitability for drinking [52–56]. The tool for influencing a substance in the implementation of such technologies is a non-equilibrium plasma—an ionized gas consisting of electrons, ions, and neutral particles. It is known that an electric discharge in gases and liquids is not only one of the most relatively simple ways to create plasma states of matter, but itself, in turn, has several types: glow, spark, arc, corona, and high-voltage breakdown in a liquid. The implementation of each type of electric discharge leads to the emergence of plasma chemical and plasma physical processes of varying intensity, which can play a significant role in solving water purification problems.

Recognizing the predominant use of chlorination technology for the disinfection of wastewater at present and the inertia of the processes of introducing the latest water treatment methods, one should use the important advantage of this method, namely a prolonged effect on pathogenic microorganisms, and, supplementing it with other methods of disinfection, reduce the harmful effects of chlorination on the environment.

One of the options for solving this problem can be a synergistic technology, the subject of our research, including the complex effect on water of a high-voltage electric discharge simultaneously with chlorination, and the goal of the work is a significant decrease in the concentration of chemicals necessary in this case compared to traditional chlorination and a simultaneous decrease in the energy of high-voltage electric discharge required to achieve the effect of disinfection.

In our studies, we proceeded from the hypothesis that the main mechanism of action on objects (bacteria) is oxidizing particles that appear in the liquid as a result of sonolysis in the entire volume of the discharge chamber. In this case, we assumed that the cause of sonolysis is cavitation; the source of cavitation, under certain conditions, can be an electric discharge. The most well-known consequence of high-voltage breakdown of liquids is shock waves. However, when shock waves act on objects with dimensions smaller than the width of the wavefront (e.g., bacteria), the objects are simply exposed to quasi-static all-around compression. Thus, the direct role of a shock wave in a liquid when it acts on small objects cannot be overestimated.

Let us consider the essence of high-voltage liquid breakdown. If an electric voltage above the critical value is applied to a pair of electrodes immersed in a liquid (weak electrolyte), a breakdown occurs: a plasma channel appears, through which an electric current flows. However, before an electric discharge channel appears in the electrode's gap, some time passes—the static delay time. During this short period of time, a current already appears in the discharge gap, because the processes of liquid ionization start, the formation of plasma begins, and initial plasma formations (streamers) are moving from the anode to the cathode. Then, some more time passes—the stage of breakdown's preparation. As the brush of streamers develops, some of them slow down and disappear, and only one of them reaches the counter electrode. The stage of discharge formation is characterized by an additional slow increase in current and a slight drop in voltage. It is important that energy losses occur at the stage of breakdown's preparation. This energy is expended

on the heating of liquid and the formation of vapor bubbles. The delay and breakdown stages together last from a few microseconds to hundreds of microseconds in total and are collectively combined into the so-called “pre-breakdown stage”.

The pre-breakdown stage ends with the formation of a highly conductive electric discharge channel (breakdown)—the electric current increases sharply, and the voltage drops. The energy accumulated by the capacitor bank is rapidly injected into the formed plasma channel of the electric discharge. The substance in the electric discharge channel is heated up to a temperature of 20,000 . . . 40,000 K, and the pressure rises to 300 . . . 1000 MPa. Under the action of this pressure, the discharge channel expands, and the channel walls receive high velocities (as a rule, much more than the speed of sound in the liquid). The stage of active energy conversion in the electric discharge channel takes from several tens to several hundreds of microseconds. Then the accelerated motion of the walls of the discharge channel stops, and they continue to move more slowly, forming a vapor–gas cavity. After reaching equilibrium, the cavity closes to a minimum size, expands again, and continues to oscillate with decreasing amplitude and periods. In short periods of time, when the cavity closes to a minimum size, secondary compression waves are formed in the liquid.

This is the stage, which lasts several milliseconds after the electric discharge channel disappearance, that is very important for creating cavitation in the entire volume of the chamber. The point is that multiple cavitation breaks in a liquid can occur only on cavitation “germs” after the excitation of a negative (tensile) pressure in the liquid. That is, a necessary condition for the development of cavitation in the entire volume of the chamber is the presence of germinal bubbles in the liquid, and the cavitation phenomenon strongly depends on the initial amount of the gas phase in the treated liquid.

In ordinary water, there are relatively few bubbles, i.e., cavitation germs, and in order to cause cavitation in the entire volume, it is necessary to ensure their occurrence before tensile stresses are excited in the liquid. We use the phenomena occurring at the pre-breakdown stage as a way to create multiple cavitation germs in working liquids. If a mode of high-voltage breakdown of the liquid is provided, which will give active gas formation at the pre-breakdown stage, then all the cavitation germ bubbles will shrink–stretch after the main vapor–gas cavity.

Post-discharge cavitation processes are observed in this case in the far (from a few milliseconds to hundreds of milliseconds) time interval in the entire volume of the working chamber. It is very possible to create conditions for the formation of numerous bubbles (germs): with a relatively long voltage pulse, gas formation is facilitated due to boiling and electrolysis. Nevertheless, the condition of the breakdown of the discharge gap is mandatory for the powerful electric discharge cavitation to arise. Liquid breakdown causes the appearance of compression–tension waves in the primary gas–vapor cavity; in addition, the shock wave destroys the gas phase formed at the pre-breakdown stage, and a cloud of microscopic bubbles (germs) is formed. As a result, conditions for the occurrence of cavitation in the region of each bubble are created. Thus, for the occurrence of powerful electric discharge cavitation, high gas generation at the pre-breakdown stage and breakdown of the liquid are necessary. The issues of the origin and development of volumetric electric discharge cavitation in a liquid and its control are considered in detail in [57–62].

2. Materials and Methods

The study of the possibility of reducing the concentration of the chlorine agent during complex use with an electric discharge was carried out on a laboratory electric discharge installation [63] (Figure 1). The laboratory setup provided an operating voltage (U) of 15 to 25 kV, the capacitance of the capacitor bank (C) varied from 0.1 to 1 μF , and the discharge frequency (f) was from 1 to 5 Hz. The energy in one pulse (W) changed both due to the voltage and due to the capacitance of the capacitor bank according to the well-known expression $W = \frac{CU^2}{2}$. Such wide possibilities for changing the energy in a pulse were

necessary to determine the combination of electrical parameters for the electric discharge mode with large gas formation at the pre-breakdown stage and the obligatory liquid breakdown—a special cavitation mode. The frequency of the discharges was changed from 1 to 5 Hz, because the effect of volumetric cavitation that is of interest to us during an electric discharge occurs within milliseconds after the breakdown of the liquid itself.

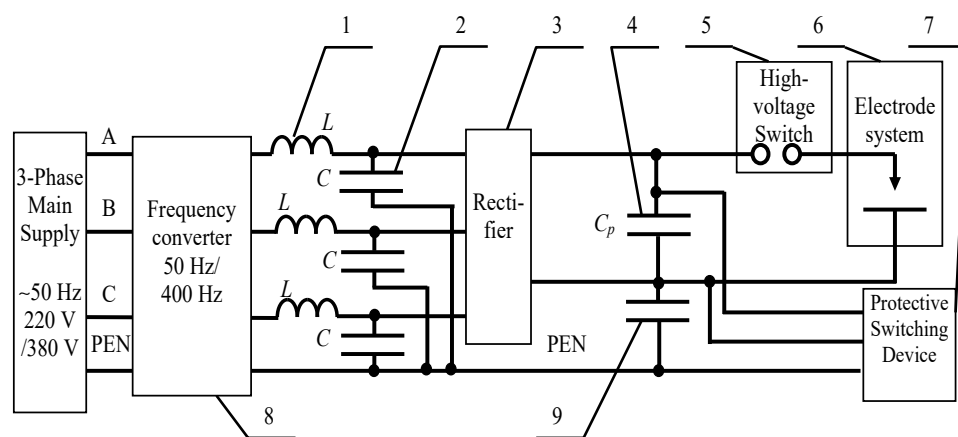

Figure 1. Laboratory electric discharge installation.

The high-voltage pulse current generator was connected to the industrial three-phase main supply. The generator contained three identical inductors 1, three identical high-voltage capacitors 2, the three-phase high-voltage rectifier 3, the capacitive energy storage device 4, the high-voltage switch 5, the working chamber and electrode system 6, and the protection system 7. The high-voltage pulse current generator was equipped with the three-phase frequency converter 8 and the dividing capacitor 9.

Cylindrical working chambers with volumes of 1, 2, and 3 dm³ were made of fluoroplastic; the main electrode system of the “point–plane” type was made of titanium alloy, the diameter of the electrode point was 4 mm, and the interelectrode gap was changed from 4 to 15 mm, because the interposition and ratio of the dimensions of the working chamber and the electrode system are also important for obtaining the cavitation mode of the electric discharge. The choice of titanium as an electrode material made it possible to avoid intense electroerosion and to exclude the influence of additional contaminants affecting oxidative processes in the aquatic environment. For a targeted study of the effect of electrode erosion processes on water disinfection, steel, brass, and aluminum electrodes of the same design were used.

As shown above, one of the conditions for the occurrence of powerful cavitation during an electric discharge is the presence of as many gas bubbles as possible in the liquid. The effect of water boiling at temperatures below 100 °C if the pressure is lower than standard atmospheric one is widely known; for example, in the mountains at an altitude of approx. 5000 m (pressure about 0.5 atm.), water boils at 80 °C. In this work, an attempt was made to intensify the formation of cavitation germs by reducing the external pressure. To create reduced pressure, the working chamber was placed in a hermetically sealed container, from which air was pumped out with a vacuum pump.

Bacteriological tests were carried out in the laboratory of the Inhulets water treatment facilities of the Mykolaivvodokanal enterprise. Since the concentration of *Escherichia coli* (*E. coli*) is the main sanitary indicator microorganism, the bactericidal effect was studied using this test object. Water for treatment was taken from the wastewater masses of the Inhulets treatment facilities; the initial content of *E. coli* varied from 10⁴ to 10⁶ CFU/dm³ depending on the time of water intake. To avoid additional contamination of the water after treatment, all used glassware was subjected to a preliminary heat treatment at 433 K for 2 h, and the containers for sampling treated with an electric discharge were sterilized by flambéing. Determination of *E. coli* was carried out by the method of membrane filters.

For indirect quantitative determination of the intensity of the formation of oxidants during the electric discharge treatment of water, the iodometric titration method was used, adapted to study the consequences of electric discharge processes in water [64]. The method is based on the oxidation of *KI* solutions, which is accompanied by the release of I_2 ; its content can, in turn, be quantified by titration:

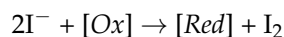

where: $[Ox]$ particle is the oxidizing agent and $[Red]$ is the reduced form of the oxidizing particle.

The isolated iodine was titrated with a solution of sodium thiosulfate until the disappearance of the blue color of the solution, which is formed when starch is used as an indicator. The process is described by the following reaction equation:

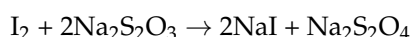

It can be seen that the described processes in the system occur without the participation of hydrogen ions; this allows iodometric determinations to be made in a wide range of solution acidity ($pH = 2 \dots 10$). For example, the content of active chlorine (chlorine radicals, hypochlorite ions, hypochlorous acid, etc.) $[Cl^*]$ in mg/dm^3 was calculated using Equation (1):

$$[Cl^*] = \frac{(a \cdot b) \cdot k \cdot 0.01 \cdot 35.45 \cdot 1000}{V} = \frac{(a \cdot b) \cdot k \cdot 354.5}{V}, \quad (1)$$

where:

a —volume of 0.01 N sodium thiosulfate solution used for sample titration, mL;

b —volume of 0.01 N sodium thiosulfate solution used for titration in a blank determination, mL;

k —correction factor to bring the concentration of sodium thiosulfate solution exactly to 0.01 N;

V —volume of the analyzed sample, mL;

35.45—atomic weight of chlorine;

0.01—normality of sodium thiosulfate solution.

3. Results and Discussion

The bactericidal effect of the specific energy of an electric discharge introduced into the volume of disinfected water without the addition of any chemical oxidizing agents is shown in Figure 2.

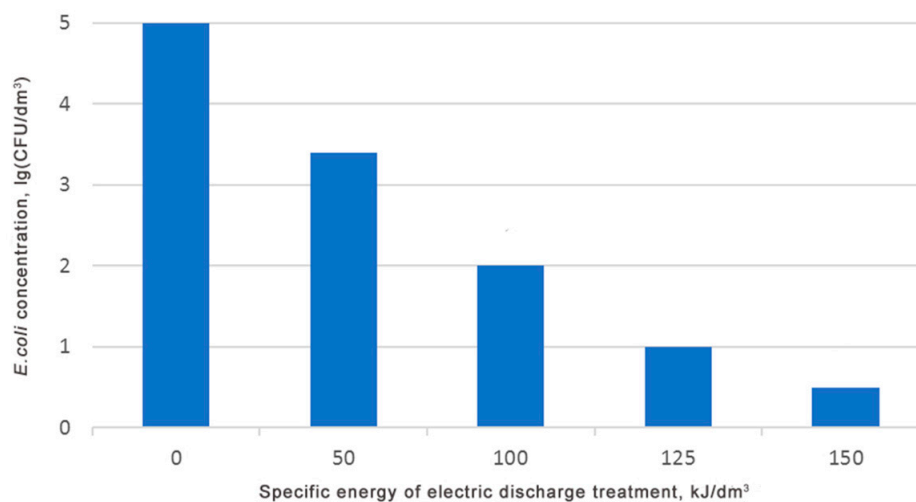

Figure 2. Dependence of *E. coli* concentration on the specific energy of electric discharge treatment.

It can be seen that with an increase in specific energy, the concentration of bacteria decreases; at an initial concentration of *E. coli* 10^5 CFU/dm³ and $E_{sp} = 150$ kJ/dm³ (41 kWh/m³), a good, but not 100%, bactericidal effect is observed. However, with such specific energy consumption, it is meaningless to talk about the practical application of electric discharge installations. Therefore, the main ideology of our research, as stated, was based on the discovery of a synergistic effect of chemical and electrical discharge treatment.

Data on the bactericidal effect during the successive action of an electric discharge and chlorination on water are presented in Figure 3. According to one scheme, water was first treated with an electric discharge, reducing the specific energy of treatment to 50 kJ/dm³ (approximately 13 kWh/m³), and then the treated water was chlorinated, bringing the indicators of epidemic safety of drinking water according to *E. coli* $[Cl^*] = 5$ mg/dm³ (the total exposure time was 2 h) (Figure 3a); in the other scheme, water, previously chlorinated (exposure time 10 min), was subjected to electric discharge treatment for 20 s with a specific energy of 50 kJ/dm³, and in this case, the concentration of active chlorine was reduced to $[Cl^*] = 1$ mg/dm³ (Figure 3b).

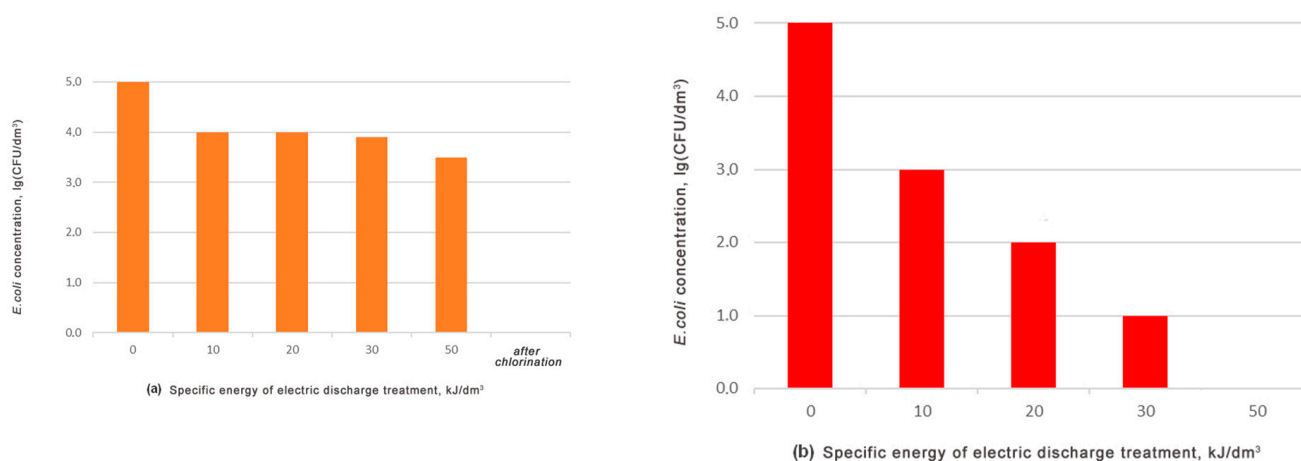

Figure 3. Dependence of *E. coli* concentration on the specific energy of electric discharge treatment during sequential electric discharge chemical treatment: (a) sequential treatment electric discharge + chlorination $[Cl^*] = 5$ mg/dm³; (b) sequential treatment chlorination $[Cl^*] = 1$ mg/dm³ + electrical discharge.

It is important to note that in both cases, an important advantage of the chlorination method was preserved—a prolonged action. If in the first treatment scheme, this can be attributed to an excess of active chlorine in the treated water, then the second scheme, at a concentration of active chlorine 5 times lower, also made it possible to obtain water that remained sterile even after settling for 48 h after treatment.

The next stage of our work was aimed at further reducing energy consumption and reducing the concentration of the chlorine agent by combining electric discharge and chemical treatment. The stage of preliminary chlorination was excluded, and the electrical discharge treatment started immediately after the addition of the chlorine agent at a concentration of $[Cl^*] = 1, 0.8, 0.6, 0.4, 0.2$ mg/dm³, but the pulse frequency was reduced from 4 to 1 Hz.

During the treatment, water samples were taken with an interval of 5 kJ/dm³ of input energy, and the initial concentration of *E. coli* was 10^6 CFU/dm³; the results are shown in Figure 4.

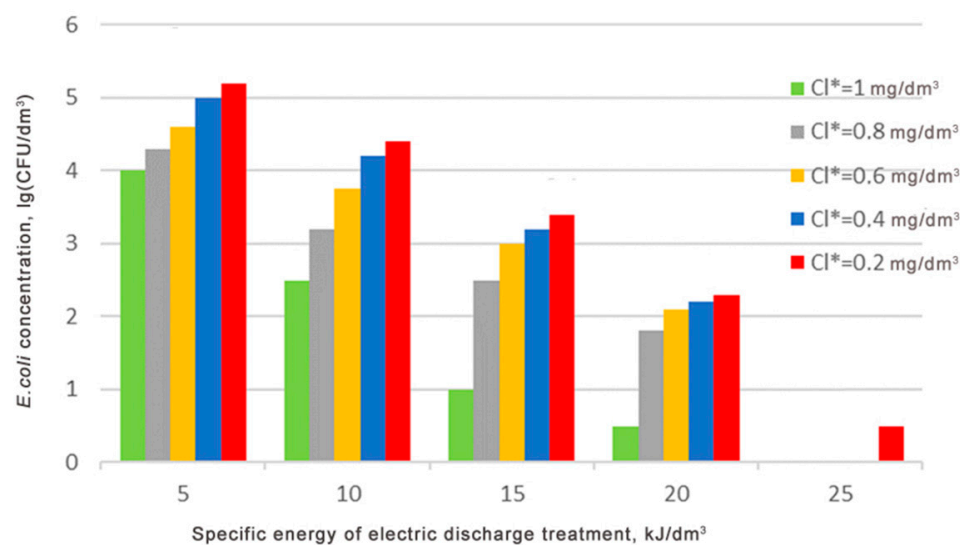

Figure 4. Dependence of *E. coli* concentration on the specific energy of electric discharge treatment with simultaneous electric discharge–chemical treatment.

As follows from the presented histogram, the addition of chlorine in the amount of 0.4 mg/dm³ or more and simultaneous electric discharge treatment give a good bactericidal effect—after the introduction of a specific energy of 25 kJ/dm³ into the aqueous solution of the chlorine by the electric discharge method, no colony-forming units of *E. coli* were observed in the samples. Such treatment also retains a prolonged action—after settling for 48 h after treatment, water samples with the content of [Cl*] = 1, 0.8, 0.6, 0.4 mg/dm³ remained sterile, and in the sample with [Cl*] = 0.2 mg/dm³, the number of colony-forming units increased from 3 to 200.

Thus, a synergistic effect is observed in the combined treatment of contaminated water by chlorination and electric discharge: the bactericidal effect of such a combination is more powerful than each method separately, taking into account a significant reduction in the energy and chemical reagents spent. The following mode of processing can be preliminarily recommended: electrical parameters: operating voltage 25 kV, energy storage capacity 0.25 μF, pulse frequency 1 Hz—such a combination [65] is in the range of high-voltage electric discharge modes that allow generating post-discharge cavitation; processing time 20 ... 30 s, specific energy 25 kJ/dm³, [Cl*] = 0.4 ... 0.5 mg/dm³.

Of great interest is the mechanism of the bactericidal action of an electric discharge. To date, the question of the influence of numerous factors that occur during an electric discharge in water on microorganisms remains open and is discussed at the level of hypotheses [46,55,56].

Considering that the object of treatment is rather small (*E. coli* dimensions are 0.4 ... 0.8 × 1 ... 3 μm), it can be assumed that the mechanisms of action are at the molecular level, that is, such factors of the electric discharge as a shock wave and magnetic and electric fields (considering the wavelength of their action) can be neglected. The most probable sources of intensification of redox processes in this case can be photolysis (UV and the visible part of the electric discharge spectrum), electrolysis (pulse flow of electric current), sonolysis (ultrasonic component of the electric discharge spectrum), and volumetric cavitation due to the occurrence of powerful hydroacoustic flows.

Using KI as an indicator of redox processes in tap water during treatment with an electric discharge, the following was shown:

(1) When only the light component of the discharge was exposed to the KI solution (a transparent polyethylene container with 2 g/dm³ KI was placed in the discharge chamber), no formation of I₂ was observed.

This indicates the absence of a photocatalytic reaction $\text{H}_2\text{O} \rightarrow \text{OH}^- + \text{H}^+$ with subsequent oxidation according to the following reactions: $\text{KI} + \text{OH}^- \rightarrow \text{I}^- + \text{KOH}$; $2\text{I}^- \rightarrow \text{I}_2 \downarrow$.

Under the described conditions, there is no bactericidal effect, because the intensity of the light flux and the range of wavelengths of UV radiation generated by an electric discharge in water are not lethal to bacteria.

(2) Treatment of a solution containing 2 g/dm³ NaCl, unlike solutions of KI, does not lead to the release of Cl₂, although in the usual electrolysis of table salt, the primary reaction at the anode is the decomposition of chloride ions with the release of gaseous chlorine. This allows us to conclude that pulsed electrolysis is not the cause of the observed formation of I₂ during the electric discharge KI treatment: $2\text{Cl}^- - 2\text{e}^- \rightarrow \text{Cl}_2\uparrow$.

(3) KI treatment by solutions with ultrasound at a frequency of 22 kHz and an intensity of about 0.5 W/cm² leads to a slow accumulation of I₂ (a blue color appears in the KI + starch system). In the work of Ku and others [66], it was shown that during ultrasonic treatment of solutions, the main factor of the sonochemical effect is the process of “collapse” of cavitation bubbles. Obviously, under the action of ultrasound, the intensity of cavitation is not high, and, accordingly, the process of I₂ accumulation is slow.

Thus, it can be assumed that in the case of electric discharge treatment of aqueous solutions, the main factor influencing the appearance of oxidizing particles is volumetric cavitation.

To test this assumption, the effect of simultaneous electric discharge treatment and chlorination on the disinfection process at a reduced relative to atmospheric pressure was studied. As shown earlier [67–69], powerful volumetric cavitation occurs in the electric discharge reactor. Treatment of water with the initial content of *E. coli* = 10⁶ CFU/dm³ was carried out at a pressure reduced to 0.08, 0.06, and 0.04 MPa, an operating voltage of 18 kV, a storage capacity of 0.25 μF, a pulse frequency of 2.5 Hz, the [Cl*] content of 0.3 mg/dm³, and the treatment time of 6 s, and the specific energy introduced into the liquid was only 5 kJ/dm³. In all experiments with reduced pressure, a 100% bactericidal effect was observed at the end of the treatment, and the water content of *E. coli* satisfied the requirements for drinking. This once again confirms that the main disinfecting factor in the process of electric discharge treatment in this case is volumetric cavitation.

Some researchers in their works attribute the bactericidal effect of water treatment with an electric discharge to the erosion of electrodes, which is inevitable with this kind of treatment [70,71]. The destruction of the electrodes during the passage of high discharge currents leads to the appearance of metal ions in the liquid, some of which have an oligodynamic effect. Water with small amounts of positive metal ions (for example, copper and silver) is a fatal environment for microorganisms; a study of the survival of *E. coli* bacteria in water treated with so-called diaphragm electric discharges confirmed the oligodynamic effect of the electrode material [72,73]. Experiments were carried out to identify the dependence of the degree of electrode erosion on various electrical parameters [74]. Obviously, the erosion of electrodes is greatly influenced by the energy released in the electrode gap. The concentrations of iron, aluminum, and copper in water increase in proportion to the increase in the input energy, and the erosion of a brass electrode, for example, at the same energy density, is approximately 2 times higher than that of a steel one.

More important for us was the study of the dependence of the number of oxidizers formed in the course of an electric discharge on the electrode material. During the implementation of an electric discharge with an operating voltage of 25 kV, an energy storage capacity of 0.25 μF, a pulse frequency of 1 Hz, a processing time of 20 . . . 30 s, and a specific energy of 150 kJ/dm³ in distilled water, it was found that the yield of oxidants detected by the iodometric method weakly depends on the electrode material and increases with increasing energy density. Carrying out the treatment of contaminated water with an initial content of *E. coli* = 10⁴ CFU/dm³, similar in terms of electrical parameters, with a specific input energy of 25 kJ/dm³ without the addition of chemical reagents showed a greater efficiency of electrode systems made of aluminum and brass in terms of disinfection (Figure 5).

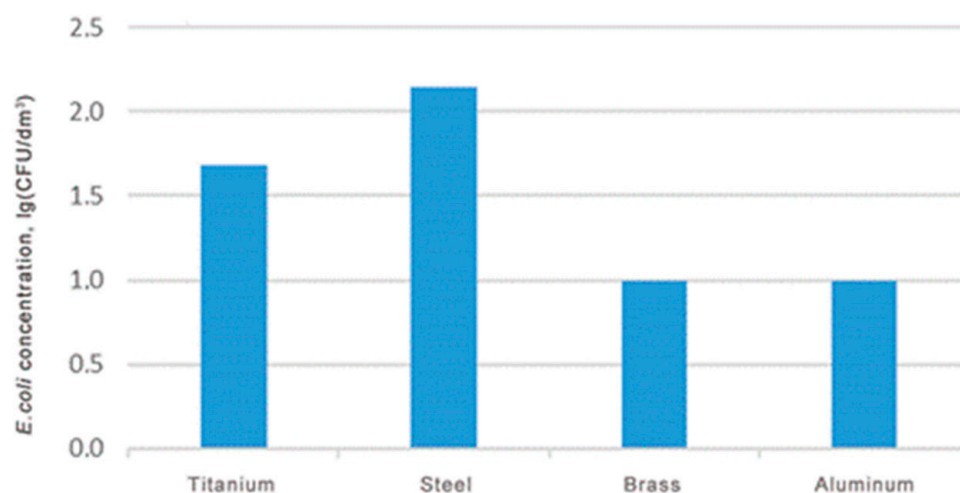

Figure 5. Bactericidal properties of various electrode materials during electrodischarge treatment.

Nevertheless, taking into account the high electroerosive ability of copper and aluminum, and, consequently, the high wear rate of the electrodes and the poorly controlled contamination of the treated water with erosion products, the maximum allowable concentrations of which can be quickly exceeded during processing, electrodes are preferable for the practical application of the electric discharge cavitation processing method from titanium.

4. Conclusions

Thus, a synergistic effect was shown in the joint treatment of water with a chlorine agent and an electric discharge. The use of this effect will reduce the bactericidal doses of chlorine to 0.4 . . . 0.5 mg/dm³ (10 times less than the existing standards), with energy costs for the electric discharge effect of about 25 kJ/dm³, 6 times less than without the introduction of oxidizing agents, and significantly reduce the time of the chlorination process, while providing a prolonged bactericidal effect.

The decisive influence of volumetric cavitation on the process of disinfection by the electric discharge method has been experimentally confirmed. The development of the method should be continued in terms of creating a phenomenological model of electric discharge cavitation and clarifying the mechanism of its bactericidal action.

Author Contributions: Conceptualization, A.P.M. and A.Y.; methodology, A.P.M.; software, A.Y.; validation, P.K. and O.M.; formal analysis, P.K.; investigation, O.M.; resources, A.P.M.; data curation, P.K.; writing—original draft preparation, A.P.M.; writing—review and editing, A.M.; visualization, O.M.; supervision, R.G.-R.; project administration, P.K. All authors have read and agreed to the published version of the manuscript.

Funding: This research received findings of Rzeszów University of Technology.

Data Availability Statement: The authors confirm that the data supporting the findings of this study are available within the article. Raw data that support the findings of this study are available from the corresponding authors, upon reasonable request.

Conflicts of Interest: The authors declare no conflict of interest.

References

1. Bezsonov, Y.; Mitryasova, O.; Smyrnov, V.; Smyrnova, S. Influence of the South-Ukraine electric power producing complex on the ecological condition of the Southern Bug River. *East.-Eur. J. Enterp. Technol.* **2017**, *4*, 20–28. [[CrossRef](#)]
2. Mitryasova, O.; Pohrebennyk, V.; Kochanek, A.; Stepanova, O. Environmental Footprint Enterprise as Indicator of Balance it's Activity. In Proceedings of the 17th International Multidisciplinary Scientific Geoconference SGEM 2017, Albena, Bulgaria, 29 June–5 July 2017; Volume 51, pp. 371–378.

3. Pohrebennyk, V.; Cygnar, M.; Mitryasova, O.; Politylo, R.; Shybanova, A. Efficiency of Sewage Treatment of Company “Enzyme”. In Proceedings of the 16th International Multidisciplinary Scientific Geoconference SGEM 2016, Albena, Bulgaria, 30 June–6 July 2016; Volume II, pp. 295–302.
4. Ishchenko, V.; Pohrebennyk, V.; Kochan, R.; Mitryasova, O.; Zawislak, S. Assessment of Hazardous Household Waste Generation in Eastern Europe. In Proceedings of the International Multidisciplinary Scientific Geoconference SGEM 2019, Albena, Bulgaria, 30 June–6 July 2019; Volume 19, pp. 559–566.
5. Terranna, H.; Janke, R.; Murray, R.; Burkhardt, J.; Grayman, W.; Ernst, H. *Future of Water Distribution Modeling and Data Analytics Tools*; EPA/600/R-19/174; US Environmental Protection Agency: Washington, DC, USA, 2019.
6. Mitryasova, O.; Pohrebennyk, V. Hydrochemical Indicators of Water System Analysis as Factors of the Environmental Quality State. In *Sustainable Production: Novel Trends in Energy, Environment and Material Systems. Studies in Systems, Decision and Control*; Królczyk, G., Wzorek, M., Król, A., Kochan, O., Su, J., Kacprzyk, J., Eds.; Springer: Cham, Switzerland, 2020; Volume 198, pp. 91–104.
7. Mitryasova, O.; Cieśla, M.; Nosyk, A.; Mats, A. Hydrochemical Indicators Dynamic in Surface Water. *J. Ecol. Eng.* **2021**, *22*, 111–122. [[CrossRef](#)]
8. Petrov, O.; Petrichenko, S.; Yushchishina, A.; Mitryasova, O.; Pohrebennyk, V. Electrospray Method in Galvanic Wastewater Treatment for Heavy Metal Removal. *Appl. Sci.* **2020**, *10*, 5148. [[CrossRef](#)]
9. Yusuf, A.; Amusa, H.K.; Eniola, J.O.; Giwa, A.P.; Pikuda, A.; Bilad, M.R. Hazardous and emerging contaminants removal from water by plasma-based treatment: A review of recent advances. *Chem. Eng. J. Adv.* **2023**, *14*, 100443. [[CrossRef](#)]
10. Ray, S.S.; Verma, R.K.; Singh, A.; Ganesapilai, M.; Kwon, Y. A holistic review of how artificial intelligence has redefined water treatment and seawater desalination processes. *Desalination* **2022**, *546*, 116221. [[CrossRef](#)]
11. Wu, S.; Shi, W.; Li, K.; Cai, J.; Chen, L. Recent advances on sustainable bio-based materials for water treatment: Fabrication, modification and application. *J. Environ. Chem. Eng.* **2022**, *10*, 108921. [[CrossRef](#)]
12. Anderson, L.E.; Mont, I.D.; Dunnington, D.D.; Bjorndahl, P.; Redden, D.J.; Brophy, M.J.; Gagnon, G.A. A review of long-term change in surface water natural organic matter concentration in the northern hemisphere and the implications for drinking water treatment. *Sci. Total Environ.* **2023**, *858*, 159699. [[CrossRef](#)]
13. Sewak, R.; Bena, D.; Sewak, P.; Mahajan, S. Ground-tested principles of designing a robust drinking water treatment system. *Water Secur.* **2021**, *14*, 100103. [[CrossRef](#)]
14. Malyushevskaya, A.; Yushchishina, A.; Mitryasova, O.; Pohrebennyk, V.; Salamon, I. Optimization of Extraction Processes of Water-Soluble Polysaccharides under the Electric Field Action. *Przegląd Elektrotechniczny* **2021**, *97*, 73–76. [[CrossRef](#)]
15. Malyushevskaya, A.; Koszelnik, P.; Yushchishina, A.; Mitryasova, O.; Gruca-Rokosz, R. Green Approach to Intensify the Extraction Processes of Substances from Plant Materials. *J. Ecol. Eng.* **2022**, *23*, 197–204. [[CrossRef](#)]
16. Malyushevskaya, A.; Koszelnik, P.; Yushchishina, A.; Mitryasova, O.; Mats, A.; Gruca-Rokosz, R. Eco-Friendly Principles on the Extraction of Humic Acids Intensification from Biosubstrates. *J. Ecol. Eng.* **2023**, *24*, 317–327. [[CrossRef](#)]
17. Martin, J.F.; Topudurti, K.; Labunski, S. Demonstration of Microfiltration Technology. *J. Air Waste Manag. Assoc.* **1991**, *41*, 10466960. [[CrossRef](#)]
18. Abdessemed, D.; Nezzal, G.; Aim, B.R. Treatment of wastewater by ultrafiltration. *Desalination* **1999**, *126*, 1–5. [[CrossRef](#)]
19. Gagliardo, P.; Adham, S.; Trussell, R.; Olivieri, A. Water repurification via reverse osmosis. *Desalination* **1998**, *117*, 73–78. [[CrossRef](#)]
20. Liu, S.; Song, W.; Meng, M.; Xie, M.; She, Q.; Zhao, P.; Wang, X. Engineering pressure retarded osmosis membrane bioreactor (PRO-MBR) for simultaneous water and energy recovery from municipal wastewater. *Sci. Total Environ.* **2022**, *826*, 154048. [[CrossRef](#)]
21. Clever, M.; Jordt, F.; Knauf, R.; Rübiger, N.; Rüdibusch, M.; Hilker-Scheibel, R. Process water production from river water by ultrafiltration and reverse osmosis. *Desalination* **2020**, *131*, 325–336. [[CrossRef](#)]
22. Beyer, M.; Lohrengel, B.; Nghiem, L.D. Membrane fouling and chemical cleaning in water recycling applications. *Desalination* **2010**, *250*, 977–981. [[CrossRef](#)]
23. Zularisam, A.W.; Ismail, A.F.; Sakinah, M. Application and Challenges of Membrane in Surface Water Treatment. *J. Appl. Sci.* **2010**, *10*, 380–390. [[CrossRef](#)]
24. Shao, B.; Shen, L.; Liu, Z.; Tang, L.; Tan, X.; Wang, D.; Zeng, W.; Wu, T.; Pan, Y.; Zhang, X.; et al. Disinfection byproducts formation from emerging organic micropollutants during chlorine-based disinfection processes. *Chem. Eng. J.* **2022**, *445*, 140476. [[CrossRef](#)]
25. How, Z.T.; Kristiana, I.; Busetti, F.; Linge, K.L.; Joll, C.A. Organic chloramines in chlorine-based disinfected water systems: A critical review. *J. Environ. Sci.* **2017**, *58*, 2–18. [[CrossRef](#)]
26. Li, T.; Wang, Z.; Wang, C.; Huang, J.; Zhou, M. Chlorination in the pandemic times: The current state of the art for monitoring chlorine residual in water and chlorine exposure in air. *Sci. Total Environ.* **2022**, *838*, 156193. [[CrossRef](#)] [[PubMed](#)]
27. Plaza-Garrido, A.; Limaico, M.; Villamar-Ayala, C.A. Influence of wastewater treatment technologies on virus removal under a bibliometric-statistical analysis. *J. Water Process Eng.* **2022**, *47*, 102642. [[CrossRef](#)]
28. Gohil, J.M.; Suresh, A.K. Chlorine attack on reverse osmosis membranes: Mechanisms and mitigation strategies. *J. Membr. Sci.* **2017**, *541*, 108–126. [[CrossRef](#)]
29. Foroughi, M.; Khiadani, M.; Kakhki, S.; Kholghi, V.; Naderi, K.; Yektay, S. Effect of ozonation-based disinfection methods on the removal of antibiotic resistant bacteria and resistance genes (ARB/ARGs) in water and wastewater treatment: A systematic review. *Sci. Total Environ.* **2022**, *811*, 151404. [[CrossRef](#)] [[PubMed](#)]

30. Epelle, E.I.; Macfarlane, A.; Cusack, M.; Burns, A.; Okolie, J.A.; Mackay, W.; Rateb, M.; Yaseen, M. Ozone application in different industries: A review of recent developments. *Chem. Eng. J.* **2023**, *454*, 140188. [[CrossRef](#)]
31. Joseph, C.G.; Farm, Y.Y.; Taufiq-Yap, Y.H.; Pang, C.K.; Nga, J.L.H.; Puma, G.L. Ozonation treatment processes for the remediation of detergent wastewater: A comprehensive review. *J. Environ. Chem. Eng.* **2021**, *9*, 106099. [[CrossRef](#)]
32. Morrison, C.M.; Hogard, S.; Pearce, R.; Gerrity, D.; von Gunten, U.; Wert, E.C. Ozone disinfection of waterborne pathogens and their surrogates: A critical review. *Water Res.* **2022**, *214*, 118206. [[CrossRef](#)]
33. Papageorgiou, A.; Voutsas, D.; Papadakis, N. Occurrence and fate of ozonation by-products at a full-scale drinking water treatment plant. *Sci. Total Environ.* **2014**, *481*, 392–400. [[CrossRef](#)]
34. Zhang, X.-Y.; Du, Y.; Lu, Y.; Wang, W.-L.; Wu, Q.-Y. Characteristics of the formation and toxicity index of nine newly identified brominated disinfection byproducts during wastewater ozonation. *Sci. Total Environ.* **2022**, *824*, 153924. [[CrossRef](#)]
35. Li, L. Toxicity evaluation and by-products identification of triclosan ozonation and chlorination. *Chemosphere* **2020**, *263*, 128223. [[CrossRef](#)]
36. Ye, C.; Zhang, K.; Wu, X.; Wan, K.; Cai, W.-F.; Feng, M.; Yu, X. Uncovering novel disinfection mechanisms of solar light/periodate system: The dominance of singlet oxygen and metabolomic insights. *J. Hazard. Mater.* **2023**, *443*, 130177. [[CrossRef](#)] [[PubMed](#)]
37. Sun, Z.; Li, M.; Li, W.; Qiang, Z. A review of the fluence determination methods for UV reactors: Ensuring the reliability of UV disinfection. *Chemosphere* **2022**, *286*, 131488. [[CrossRef](#)] [[PubMed](#)]
38. Tran, H.D.M.; Boivin, S.; Kodamatani, H.; Ikehata, K.; Fujioka, T. Potential of UV-B and UV-C irradiation in disinfecting microorganisms and removing N-nitrosodimethylamine and 1,4-dioxane for potable water reuse: A review. *Chemosphere* **2022**, *286*, 131682. [[CrossRef](#)] [[PubMed](#)]
39. Chauque, B.J.M.; Brandao, F.G.; Rott, M.B. Development of solar water disinfection systems for large-scale public supply, state of the art, improvements and paths to the future—A systematic review. *J. Environ. Chem. Eng.* **2022**, *10*, 107887. [[CrossRef](#)]
40. Chen, Y.D.; Duan, X.; Zhou, X.; Wang, R.; Wang, S.; Ren, N.-Q.; Ho, S.H. Advanced oxidation processes for water disinfection: Features, mechanisms and prospects. *Chem. Eng. J.* **2021**, *409*, 128207. [[CrossRef](#)]
41. Li, F.; Zhong, Q.; Kong, B.; Pan, N.; Xia, X.; Bao, Y. Synergistic effect and disinfection mechanism of combined treatment with ultrasound and slightly acidic electrolyzed water and associated preservation of mirror carp (*Cyprinus carpio* L.) during refrigeration storage. *Food Chem.* **2022**, *386*, 132858. [[CrossRef](#)]
42. Juboori, R.A.A.; Yusaf, T.; Aravinthan, V. Evaluating the impact of operating parameters on biocidal effects of pulsed ultrasound in natural water disinfection. *J. Biotechnol.* **2015**, *208*, S17–S18. [[CrossRef](#)]
43. Ziylan-Yavas, A.; Ince, N.H. Single, simultaneous and sequential applications of ultrasonic frequencies for the elimination of ibuprofen in water. *Ultrason. Sonochem.* **2018**, *40*, 17–23. [[CrossRef](#)]
44. Emerick, T.; Vieira, J.V.; Henrique, M.; Silveira, L.; João, J.J. Ultrasound-assisted electrocoagulation process applied to the treatment and reuse of swine slaughterhouse wastewater. *J. Environ. Chem. Eng.* **2020**, *8*, 104308. [[CrossRef](#)]
45. Gerrity, D.; Stanford, B.D.; Trenholm, R.A.; Snyder, S.A. An evaluation of a pilot-scale nonthermal plasma advanced oxidation process for trace organic compound degradation. *Water Res.* **2010**, *44*, 493–504. [[CrossRef](#)]
46. Moreau, M.; Orange, N.; Feuilletoy, M.G.J. Non-thermal plasma technologies: New tools for bio-decontamination. *Biotechnol. Adv.* **2008**, *26*, 610–617. [[CrossRef](#)]
47. Hafeez, A.; Shez, N.; Javed, F.; Fazal, T.; Rehman, M.S.F. Synergetic effect of packed-bed corona-DBD plasma micro-reactor and photocatalysis for organic pollutant degradation. *Sep. Purif. Technol.* **2021**, *269*, 118728. [[CrossRef](#)]
48. Mitra, N.N. The contribution of non-thermal and advanced oxidation technologies towards dissipation of pesticide residues. *Trends Food Sci. Technol.* **2015**, *45*, 229–244. [[CrossRef](#)]
49. Magureanu, M.; Bile, F.; Bradu, C.; Hong, D. A review on non-thermal plasma treatment of water contaminated with antibiotics. *J. Hazard. Mater.* **2021**, *417*, 125481. [[CrossRef](#)] [[PubMed](#)]
50. Pankaj, S.K.; Wan, Z.; Colonna, W.; Keener, K.M. Degradation kinetics of organic dyes in water by high voltage atmospheric air and modified air cold plasma. *Water Sci. Technol.* **2017**, *76*, 567–574. [[CrossRef](#)] [[PubMed](#)]
51. Lukes, P.; Clupek, M.; Sunka, P.; Peterka, F.; Sano, T.; Negishi, N.; Takeuchi, K. Degradation of phenol by underwater pulsed corona discharge in combination with TiO₂ photocatalysis. *Res. Chem. Intermed.* **2005**, *31*, 285–294. [[CrossRef](#)]
52. Njoyim-Tamungang, E.; Laminsi, S.; Ghogomu, P.; Njopwouo, D.; Brisset, J.-L. Pollution control of surface waters by coupling gliding discharge treatment with incorporated oyster shell powder. *Chem. Eng. J.* **2011**, *173*, 303–308. [[CrossRef](#)]
53. Oliveira, M.; Fernandez-Gomez, P.; Alvarez-Ordóñez, A.; Prieto, M.; Lopez, M. Plasma activated water: A cutting-edge technology driving innovation in the food industry. *Food Res. Int.* **2022**, *156*, 11368. [[CrossRef](#)] [[PubMed](#)]
54. Ho, P.Q.; Pham, T.V.; Nguyen, T.V.; Kim, L. Treatment of surface water using cold plasma for domestic water supply. *Environ. Eng. Res.* **2019**, *24*, 412–417. [[CrossRef](#)]
55. Murugesan, P.; Monica, E.; Moses, V.J.A.; Anandharamkrishnan, C. Water decontamination using non-thermal plasma: Concepts, applications, and prospects. *J. Environ. Chem. Eng.* **2020**, *8*, 104377. [[CrossRef](#)]
56. Weltmann, K.-D.; Kolb, J.F.; Holub, M.; Uhrlandt, D.; Šimek, M.; Ostrikov, K.; Hamaguchi, S.; Cvelbar, U.; Černák, M.; Locke, B.; et al. The future for plasma science and technology. *Plasma Process Polym.* **2019**, *16*, 1800118. [[CrossRef](#)]
57. Malyushevskaya, A.P.; Malyushevskii, P.P. A novel method to control electrical-discharge nonlinear bulk cavitation. *Surf. Eng. Appl. Electrochem.* **2007**, *43*, 59–64. [[CrossRef](#)]

58. Malyushevskaya, A.P.; Malyushevskii, P.P. Electrodischarge cavitation intensification in the processes of fibrous material treatment. *Surf. Eng. Appl. Electrochem.* **2008**, *44*, 253–256. [[CrossRef](#)]
59. Malyushevskaya, A.P.; Malyushevskii, P.P. Influence of free reflecting surfaces on the cavitation region excited by parallel underwater discharges. *Surf. Eng. Appl. Electrochem.* **2010**, *46*, 48–52. [[CrossRef](#)]
60. Malyushevskaya, A.P.; Malyushevskii, P.P. To the mechanism of electrodischarge enhancement of processes for the purification of plant fibers from noncellulose substances: Part 1. The processing medium, task setting, and research procedure. *Surf. Eng. Appl. Electrochem.* **2016**, *52*, 263–269. [[CrossRef](#)]
61. Malyushevskii, P.P.; Malyushevskaya, A.P.; Yushchishina, A.N. On the mechanism of electric discharge enhancement of processes for purifying plant fibers from noncellulose substances: Part 2. Chemical and electrophysical influence of electric discharge on an aqueous medium—Experimental investigations. *Surf. Eng. Appl. Electrochem.* **2017**, *53*, 383–393. [[CrossRef](#)]
62. Malyushevskaya, A.P.; Malyushevskii, P.P. Optimization of the Process of Fine Electric Discharge Dispersion. *Surf. Eng. Appl. Electrochem.* **2020**, *56*, 400–406. [[CrossRef](#)]
63. Vinnychenko, D.; Nazarova, N.; Vinnychenko, I. Transformerless High-Voltage Resonant Charging Systems for Capacitive Energy Storage Devices for Electro-Discharge Technologies. In Proceedings of the IEEE 41st International Conference on Electronics and Nanotechnology (ELNANO), Kyiv, Ukraine, 10–14 October 2022; pp. 727–731. [[CrossRef](#)]
64. Yushishina, A.N.; Malyushevsky, P.P.; Smalko, A.A. Iodometric determination of electric discharge volumetric cavitation. *Electron. Process Mater.* **2002**, *38*, 76–79.
65. Malyushevskaya, A.P.; Malyushevskij, P.P.; Levda, V.I. Electroexplosive nonlinear, volumetric cavitation in technological reactors. Part 1. Electrodischarge generation of a gas phase—Nucleus of cavitation. *Electron. Process Mater.* **2004**, *40*, 40–46.
66. Ku, Y.; Chen, K.; Lee, K.C. Ultrasonic destruction of 2-chlorophenol in aqueous solution. *Water Res.* **1997**, *31*, 929–935. [[CrossRef](#)]
67. Malyushevskaya, A.P.; Malyushevskii, P.P. Peculiarities of the Evolution of Electrical Discharge Cavitation in a Magnetic Field. *Surf. Eng. Appl. Electrochem.* **2022**, *58*, 158–166. [[CrossRef](#)]
68. Mondal, J.; Li, W.; Rezk, A.R.; Yeo, L.Y.; Lakkaraju, R.; Ghosh, P.; Ashokkumar, M. Acoustic cavitation at low gas pressures in PZT-based ultrasonic systems. *Ultrason. Sonochem.* **2021**, *73*, 105493. [[CrossRef](#)]
69. Gogate, P.R. Intensified sulfate radical oxidation using cavitation applied for wastewater treatment. *Curr. Opin. Chem. Eng.* **2022**, *37*, 100850. [[CrossRef](#)]
70. Wang, X.; Zhou, M.; Jin, X. Application of glow discharge plasma for wastewater treatment. *Electrochim. Acta* **2012**, *83*, 501–512. [[CrossRef](#)]
71. Sayinli, B.; Dong, Y.; Park, Y.; Bhatnagar, A.; Sillanpää, M. Recent progress and challenges facing ballast water treatment. *Chemosphere* **2022**, *291*, 1327764. [[CrossRef](#)] [[PubMed](#)]
72. Ragni, L.; Berardinelli, A.; Iaccheri, E.; Gozzi, G.; Cevoli, C.; Vannini, L. Influence of the electrode material on the decontamination efficacy of dielectric barrier discharge gas plasma treatments towards *Listeria monocytogenes* and *Escherichia coli*. *Innov. Food Sci. Emerg. Technol.* **2016**, *37*, 170–176. [[CrossRef](#)]
73. Hong, Y.C.; Ma, S.H.; Kim, K.; Shin, Y.W. Multihole dielectric barrier discharge with asymmetric electrode arrangement in water and application to sterilization of aqua pathogens. *Chem. Eng. J.* **2019**, *374*, 133–143. [[CrossRef](#)]
74. Smirnov, A.P.; Khvoschan, O.V.; Zhekul, V.G. Erosion of the electrode during a high-voltage electrical discharge in a liquid. *Electron. Process Mater.* **2022**, *58*, 21–33. [[CrossRef](#)]

Disclaimer/Publisher’s Note: The statements, opinions and data contained in all publications are solely those of the individual author(s) and contributor(s) and not of MDPI and/or the editor(s). MDPI and/or the editor(s) disclaim responsibility for any injury to people or property resulting from any ideas, methods, instructions or products referred to in the content.